

O300.RR-11110444

Reflexions-Lichtschranken

Retro-reflective sensors

Barrières réflex



11110444



Baumer

Baumer Electric AG · CH-8501 Frauenfeld
Phone +41 (0)52 728 1122 · Fax +41 (0)52 728 1144

Canada
Baumer Inc.
CA-Burlington, ON L7M 4B9
Phone +1 (1)905 335-8444

China
Baumer (China) Co., Ltd.
CN-201612 Shanghai
Phone +86 (0)21 6768 7095

Denmark
Baumer A/S
DK-8210 Aarhus V
Phone +45 (0)8931 7611

France
Baumer SAS
FR-74250 Fillinges
Phone +33 (0)450 392 466

Germany
Baumer GmbH
DE-61169 Friedberg
Phone +49 (0)6031 60 07 0

India
Baumer India Private Limited
IN-411038 Pune
Phone +91 20 2528 6833/34

Italy
Baumer Italia S.r.l.
IT-20090 Assago, MI
Phone +39 (0)2 45 70 60 65

Singapore
Baumer (Singapore) Pte. Ltd.
SG-339412 Singapore
Phone +65 6396 4131

Sweden
Baumer A/S
SE-56133 Huskvarna
Phone +46 (0)36 13 94 30

Switzerland
Baumer Electric AG
CH-8501 Frauenfeld
Phone +41 (0)52 728 1313

United Kingdom
Baumer Ltd.
GB-Watchfield, Swindon, SN6 8TZ
Phone +44 (0)1793 783 839

USA
Baumer Ltd.
US-Southington, CT 06489
Phone +1 (1)860 621-2121

Abmessungen Dimensions Dimensions

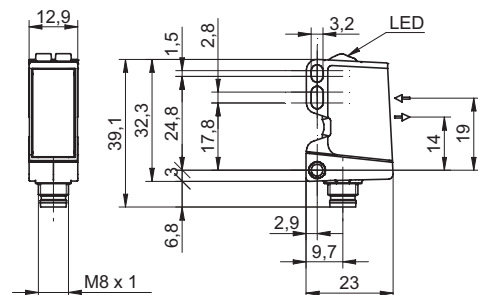

- Alle Masse in mm
- All dimensions in mm
- Toutes les dimensions en mm

Elektrischer Anschluss Connection diagram Schéma de raccordement

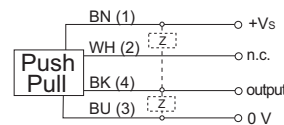

BN = Braun/brown/brun
WH = Weiss/white/blanc
BK = Schwarz/black/noir
BU = Blau/blue/bleu

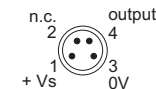

¹⁾ Class 2, UL 1310, see FAQ

- Vor dem Anschliessen des Sensors die Anlage spannungsfrei schalten.
- Disconnect power before connecting the sensor.
- Mettre l'installation hors tension avant le raccordement du détecteur.

Technische Daten

Grenzreichweite Sn	5 m
Betriebsreichweite Sb	4 m
Ausrichtung optische Achse	< 2°
Betriebsspannungsbereich +Vs ¹⁾	10 ... 30 VDC
Stromaufnahme max. (ohne Last)	30 mA
Stromaufnahme mittel	30 mA
Spannungsabfall Vd	< 3 VDC
Ansprech- / Abfallzeit	< 0,49 ms
Ausgangsschaltung	Gegentakt
Schaltfunktion	Dunkelschaltung
kurzschlussfest	ja
verpolungsfest	ja
Arbeitstemperatur	-25 ... +60 °C
Schutzart	IP 67

Technical data

nominal range Sn	5 m
actual range Sb	4 m
alignment optical axis	< 2°
voltage supply range +Vs ¹⁾	10 ... 30 VDC
current consumption max. (no load)	30 mA
current consumption typ.	30 mA
voltage drop Vd	< 3 VDC
response time / release time	< 0,49 ms
output circuit	push-pull
output function	dark operate
short circuit protection	yes
reverse polarity protection	yes
operating temperature	-25 ... +60 °C
protection class	IP 67

Données techniques

Limite de portée Sn	5 m
Portée de service Sb	4 m
Axe d'alignement optique	< 2°
Plage de tension +Vs ¹⁾	10 ... 30 VDC
Consommation max. (sans charge)	30 mA
Courant absorbé moyen	30 mA
Tension résiduelle Vd	< 3 VDC
Temps d'activation / désactivation	< 0,49 ms
Circuit de sortie	push-pull
Fonction de commutation	sombre
Protégé contre courts-circuits	oui
Protégé contre inversion polarité	oui
Température de fonctionnement	-25 ... +60 °C
Classe de protection	IP 67

O300.RR-11110444

Farben LED Colors LED Couleurs LED

Gelb
Yellow
Jaune

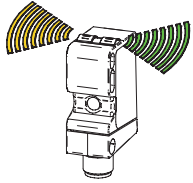

Grün
Green
Vert

LED Anzeigen LED indication Indication LED

Grün: Betriebsanzeige, Kurzschluss
Green: Operating indication, short circuit
Vert: Signalisation de service, court-circuit

Gelb: Lichtempfang
Yellow: Light reception
Jaune: Réception de lumière

Montage Mounting Montage

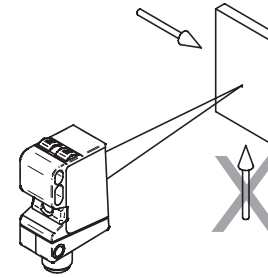

Zubehör Accessories Accessoires

Montagewinkel
Mounting bracket
Support de montage
11102423

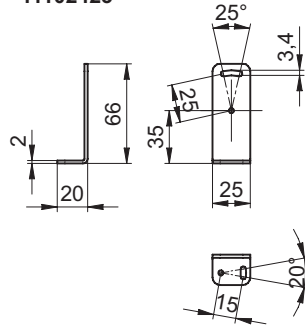

Montagewinkel
Mounting bracket
Support de montage
11124807

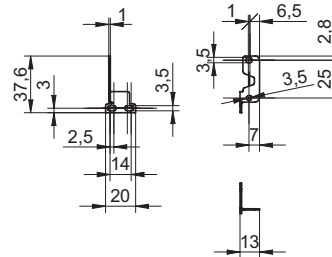

Sensofix O300
Sensofix O300
Sensofix O300
11104963

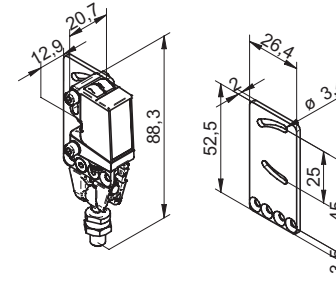

FAQ

• Netzteil nach UL 1310, Class 2?

oder externe Absicherung durch eine UL anerkannte oder gelistete Sicherung mit max. 30VAC/3A oder 24VDC/4A.

• Voltage supply according UL 1310, Class2?

or device shall be protected by an external R/C or listed fuse, rated max. 30VAC/3A or 24VDC/4A.

• L'alimentation utilisée, couvre la classe 2 selon la norme UL 1310?

Ou appareil protégé en externe par un circuit R/C ou fusible UL à 30VAC/3A ou 24VDC/4A maximum.