

# Diffuse sensors with background suppression

**O200.GR-11210540**

**dimension drawing**

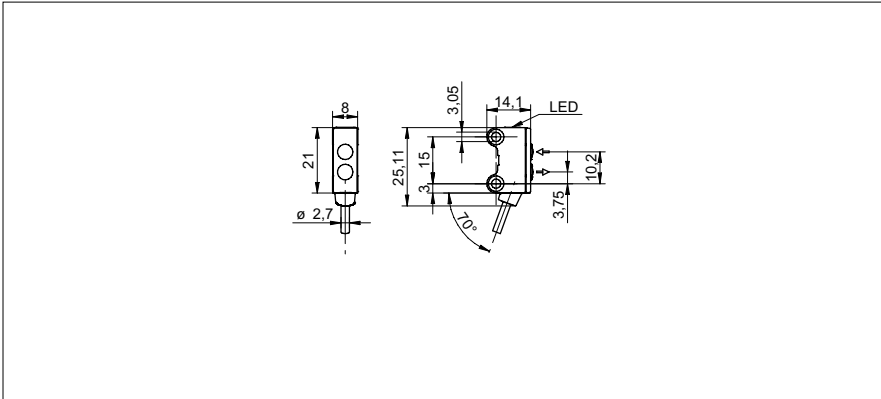

**general data**

type	background suppression
light source	pulsed red LED
sensing distance $T_w$	30 mm
sensing range $T_b$	7 ... 30 mm
smallest object recognizable typ.	0,25 mm at 30 mm
alignment / soiled lens indicator	flashing output indicator
power on indication	LED green
output indicator	LED yellow
sensing distance adjustment	no
wave length	644 nm
suppression of reciprocal influence	yes
alignment optical axis	< 1,5°

**electrical data**

response time / release time	< 1 ms
voltage supply range +Vs	10 ... 30 VDC
current consumption max. (no load)	20 mA (@ 30 VDC)
current consumption typ.	16 mA (@ 24 VDC)
voltage drop $V_d$	< 2 VDC
output function	light / dark operate
output circuit	PNP complementary
output current	< 50 mA
short circuit protection	yes
reverse polarity protection	yes

**mechanical data**

width / diameter	8 mm
height / length	25,1 mm
depth	14,1 mm
type	rectangular
mechanical mounting	sleeve smooth (stainless steel)
housing material	plastic (ASA, PMMA)
front (optics)	PMMA
connection types	cable 4 pin, 2 m
cable characteristics	PVC / PVC 4 x 0,08 mm <sup>2</sup>

**photo**



**connection diagram**

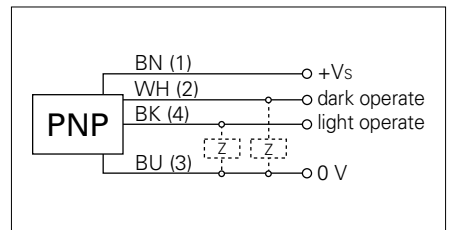

# Diffuse sensors with background suppression

**O200.GR-11210540**

**ambient conditions**

operating temperature	-25 ... +50 °C
protection class	IP 67

**beam characteristic (typically)**

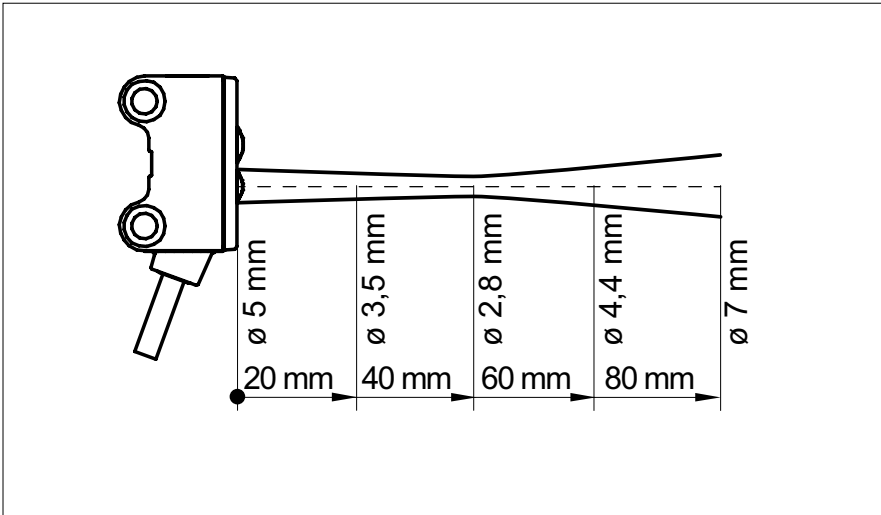

**sensing distance diagram**

