

Diffuse sensors with intensity difference

OR18.ZI-NW1Z.71CV/B012-11157792

dimension drawing

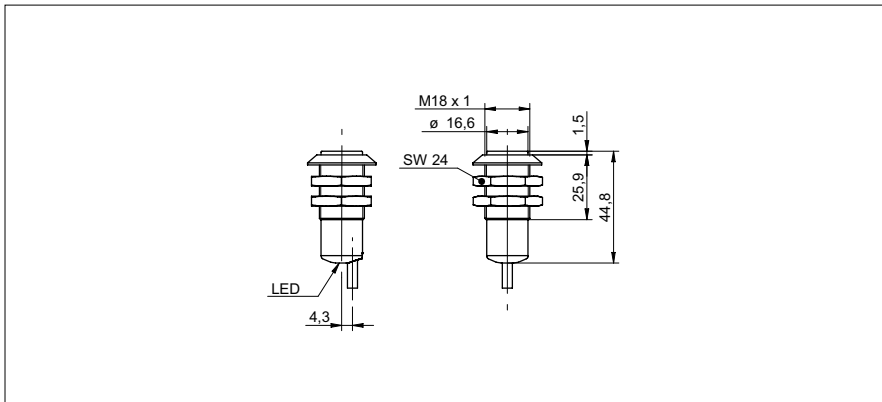

general data

type	intensity difference
light source	pulsed infrared diode
sensing distance Tw	0 ... 80 mm
alignment / soiled lens indicator	LED green
output indicator	LED yellow
sensing distance adjustment	no
wave length	880 nm
suppression of reciprocal influence	yes

electrical data

response time / release time	< 1 ms
voltage supply range +Vs	12 ... 30 VDC
current consumption max. (no load)	40 mA
current consumption typ.	30 mA
voltage drop Vd	< 2 VDC
output function	light / dark operate
output circuit	NPN
output current	< 100 mA
short circuit protection	yes
reverse polarity protection	yes

mechanical data

width / diameter	18 mm
height / length	44,8 mm
type	cylindrical threaded
housing material	plastic (ABS TERLURAN)
front (optics)	PMMA
connection types	cable 4 pin, 2 m

ambient conditions

operating temperature	-25 ... +55 °C
protection class	IP 67

photo



connection diagram

