

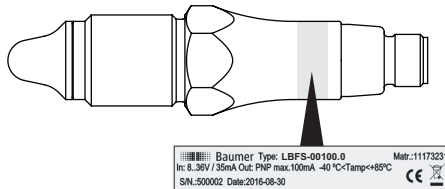





EN 50155

Type plate / Typenschild / Plaque d'identification



Type	■ Type of sensor
Matr.	■ Material number
In	■ Input voltage and power consumption
Out	■ PNP or NPN, customer-specific ■ Maximum external load
Tamb	■ Ambient temperature
S/N	■ Serial number
Date	■ Date of manufacture
	■ Do not dispose of in household waste
	■ Conformity with EU directives
	■ Approvals, type-specific

Type	■ Sensortyp
Matr.	■ Materialnummer
In	■ Eingangsspannung und Stromverbrauch
Out	■ PNP oder NPN, kundenspezifisch ■ Maximale externe Last
Tamb	■ Umgebungstemperatur
S/N	■ Seriennummer
Date	■ Herstellungsdatum
	■ Nicht im Hausmüll entsorgen
	■ Konformität mit EU-Richtlinien
	■ Zulassungen, typspezifisch



Type	■ Type de capteur
Matr.	■ Réf. mat.
In	■ Tension d'entrée et consommation électrique
Out	■ PNP ou NPN, en fonction du client ■ Charge externe maximale
Tamb	■ Température ambiante
S/N	■ Numéro de série
Date	■ Date de fabrication
	■ Ne pas jeter avec les ordures ménagères
	■ Conformité avec les directives européennes
	■ Autorisations, selon le type

Table of contents

Table of contents	3	9. Configuration	12
1. Safety	3	10. Operation	12
2. Construction and function	3	11. Cleaning, maintenance and repair.....	13
3. Symbols in warning signs.....	4	12. Disposal	13
4. Transport and storage	4	13. Accessories.....	13
5. Assembly.....	4	14. Technical data	13
6. Permissions.....	8	15. Factory settings and user settings	16
7. Electrical connection	9		
8. Electrical connection in explosion hazard areas	9		

1. Safety

Intended use

The sensor must be used solely for the level detection of liquids and solids with a dielectric constant of at least 1.5. The sensor must only be used for media against which the housing material and sensor tip are resistant.

Staff qualification

Only use staff who are trained for the activities described. This applies in particular to assembly, installation and explosion protection. Make sure that the staff have read and understood these instructions.

Technical condition

Use the sensor only when in perfect technical condition. Only use Baumer accessories. Baumer will accept no liability for other manufacturers' accessories.

Risk of burns from hot media

During operation the sensor housing may warm up to over 50 °C. When working with hot media provide protection against burns.

Explosion hazard areas

Ensure that safety requirements are complied with. Do not use equipment that would be exposed to hard impacts.

2. Construction and function

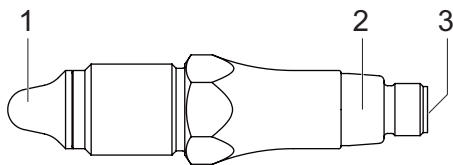

Fig. 1. Construction

- 1 Sensor tip
- 2 LED
- 3 Connection using a M12-A 4-pin connector, or a cable outlet

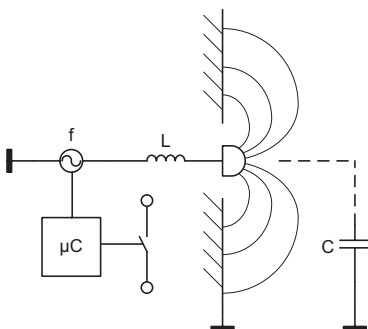



Fig. 2. Function

An electrode integrated into the sensor tip forms a capacitor with the environment. The medium determines the capacity value depending on its dielectric constant (DC values). A resonant circuit occurs together with a coil in the sensor electronics. Depending on the resonance frequency measured and the programmable trigger threshold, the switch signal is activated.

3. Symbols in warning signs

Symbol	Warning term	Explanation
	DANGER	In situations which cause death or serious injuries.
	WARNING	In situations which can cause death or serious injuries.
	CAUTION	In situations which can cause light or medium injuries.
	ATTENTION	For material damage

4. Transport and storage

- ▶ Check packaging and sensor for damage.
- ▶ In the event of damage: Do not use sensor.
- ▶ Store sensor where it will be secure against shock.
- Storage temperature: -40...+85 °C
- Relative humidity: < 98 %

5. Assembly

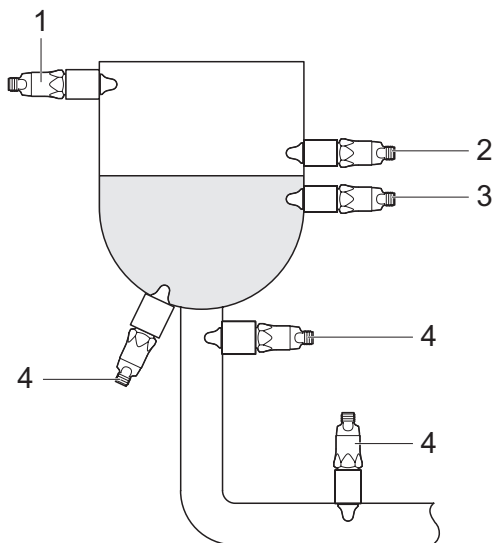

- 1 Overfill protection
- 2 Limit level, max.
- 3 Limit level, min.
- 4 Run-dry protection

The sensor can be mounted on any point in the vessel.

A sensor mounted at the top of the vessel (1) ensures against overflowing. Sensors attached further down detect a maximum (2) or minimum (3) limit level. A sensor attached at the bottom or on the outfeed pipe (4) can protect a pump against dry running.

Fig. 3. General mounting options

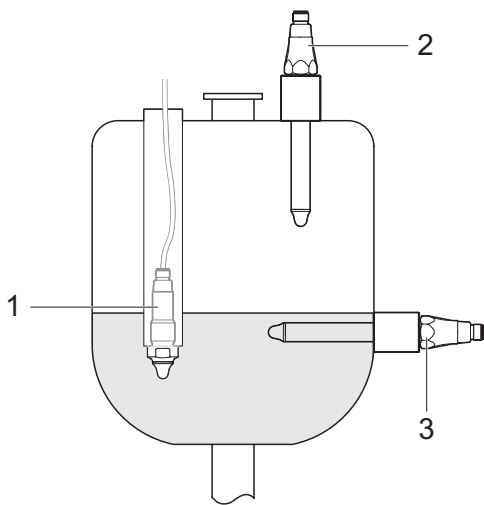

- 1 Limit level: Mounting with a tube (version 5)
- 2 Overfill protection (Type K, L)
- 3 Pasty or powdered media limit level (version K, L)

Dip length:

- Type K: 82 mm (fixed)
- Type L: 15...228 mm (adjustable)

The adjustable version L allows bridging across tank insulation.

In pasty or powdered media, the greater dip depth renders the sensor less susceptible to caking.

Fig. 4. Mounting of extended sensors

5.1 Installation for industrial applications



DANGER

Risk of injury from hazardous medium

- ▶ Wear protective equipment for hazardous media (such as acids, alkalis).
- ▶ Empty vessel and pipelines before mounting.

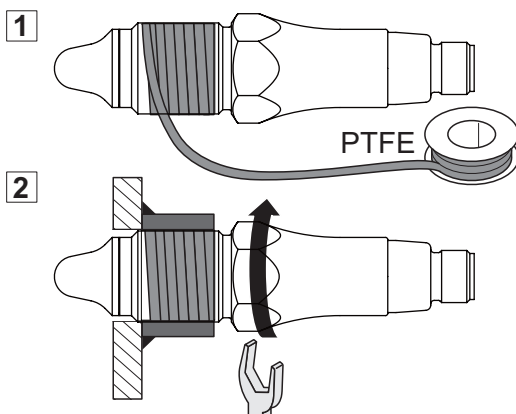

LBFS with the following process connections:

- G 1/2 A ISO 228-1 BSC (BCID G07)
- G 3/4 A ISO 228-1 (BCID G10)
- G 1 A ISO 228-1 (BCID G11)
- 1/2-14 NPT (BCID N02)
- 3/4-14 NPT (BCID N03)

✓ Vessel and pipelines are free of media.

- ▶ Seal thread on sensor with Teflon tape (PTFE).
- ▶ Screw in sensor.
Tightening torque G xx A: 30 Nm max.
Tightening torque xx-14 NPT: 20 Nm max.

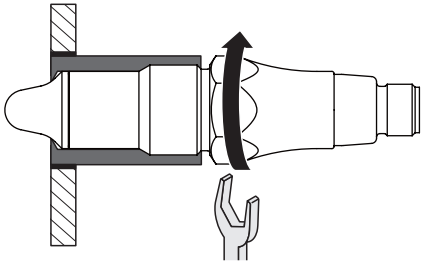
**LBFS with the following process connections:**

- G 1/2 A ISO 228-1 BSC (BCID G07) with industrial weld-in sleeve for universal use, Ø 30 x 26 (ZPW1-711, ZPW1-721)
- G 1/2 A hygienic (BCID A03) with weld-in sleeve or adapter from Baumer

For these process connections, do not seal with Teflon tape (PTFE) or elastomer.

- ✓ Vessel and pipelines are free of media.
- ✓ Adapter or weld-in sleeve are mounted free of dead space.
- ▶ Screw in sensor.
Tightening torque: 15...20 Nm

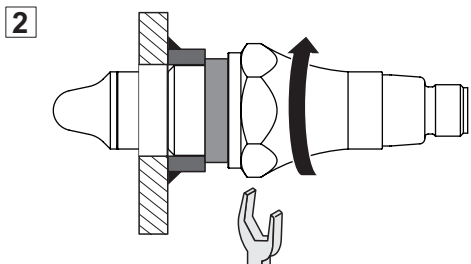
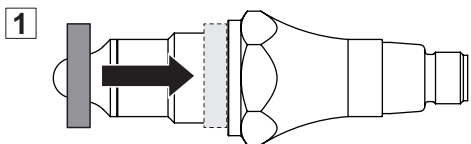
**LBFS with the following process connections:**

- G 1/2 A DIN 3852-E (BCID G51)

- ✓ Vessel and pipelines are free of media.
- ▶ Push the sealing ring on.
- ▶ Screw in sensor.
Tightening torque: 15...20 Nm

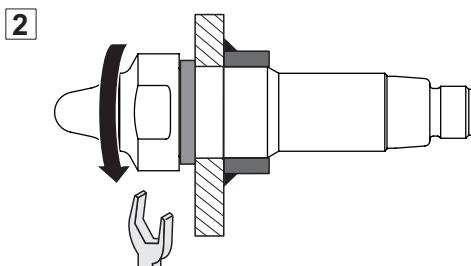
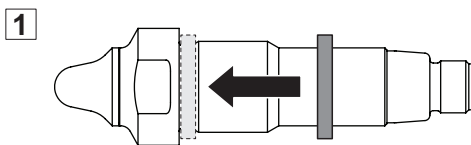
**LBFS with the following process connections:**

- G 1/2 A ISO 228-1 for internal installation (BCID T10)

- ✓ Vessel and pipelines are free of media.
- ▶ Push the sealing ring on.
- ▶ Screw in sensor.
Tightening torque: 15...20 Nm

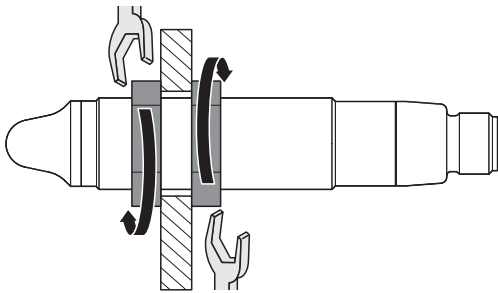

LBFS with the following process connections:

- M18x1 ISO 965 (BCID M11)

- ▶ Tighten the nuts on both sides.
Tightening torque: 15...20 Nm

5.2 Installation for hygiene applications



WARNING

Danger to health from contaminated medium

- ▶ Only use weld-in sleeves or adapters from Baumer.
- ▶ Do not seal process connections with Teflon tape (PTFE) or elastomer.
- ▶ Welding work must only be carried out by welders trained in the area of hygiene.

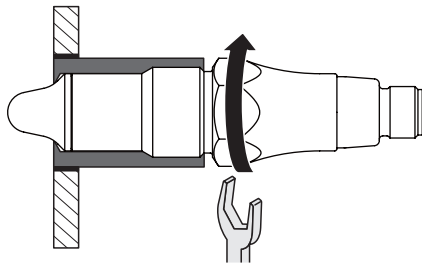

LBFS with the following process connection:

- G 1/2 A hygienic (BCID A03)

- ✓ The weld-in sleeve or adapter must be hygienically mounted and internally flush.
- ✓ Weld seams are smoothed out to $Ra < 0.8 \mu m$.
- ✓ Leakage hole points downwards.
- ▶ Screw in sensor.
Tightening torque: 10...15 Nm

1

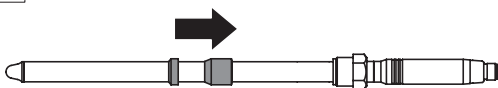

2

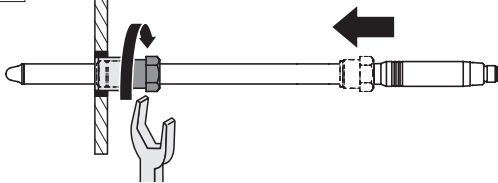

LBFS with the following process connection:

- G 1/2 A hygienic with adjustable connection (BCID A03)

- ✓ The weld-in sleeve or adapter must be hygienically mounted and internally flush.
- ✓ Weld seams are smoothed out to $Ra < 0.8 \mu m$.
- ✓ Leakage hole points downwards.
- ✓ The clamping rings must be in faultless condition (if they are deformed, replace both clamping rings).
- ▶ Push the wide clamping ring on to the guide tube.
- ▶ Push the narrow clamping ring on to the guide tube.
- ▶ Position the sensor.
- ▶ Adjust the dip depth.
Projecting length: 15...228 mm
- ▶ Tighten the screw-in pin.
Tightening torque: 10...15 Nm

Example of mounting with weld-in sleeve ZPW3-321

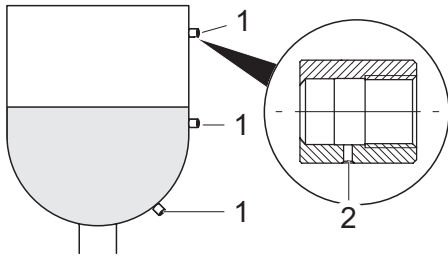

- 1 ZPW3-321
- 2 Leakage hole

Example of mounting with weld-in sleeve ZPW3-326 or ZPW3-327

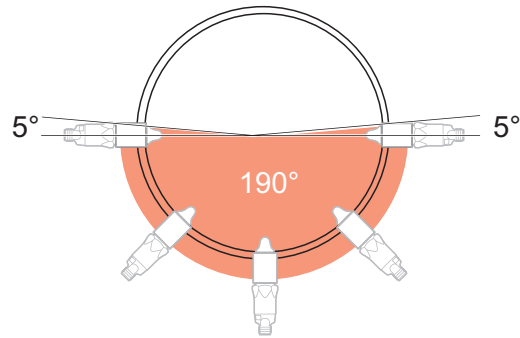
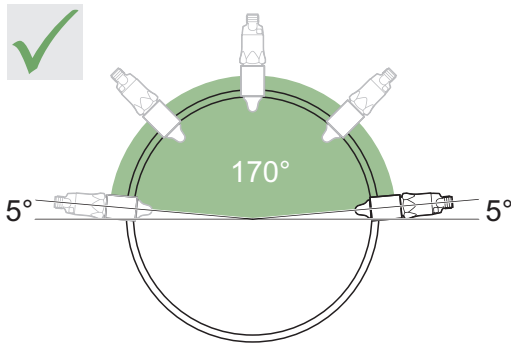

6. Approvals



The EHEDG certificate is only valid in connection with the appropriate installation parts. These are marked with the "EHEDG Certified" logo.



The 3-A Sanitary Standard requirements are only met with the appropriate installation parts. These are marked with the 3-A logo.



Approved for explosion hazard areas when installed as specified. For barriers, Baumer recommends: PROFSI3-B25100-ALG-LS.



Approved by Underwriter Laboratories (UL) for use in the USA and Canada as an industrial control device.



Certified by DNV GL for ships and offshore platforms.



WHG certified for leakage and overflow protection. All documentation must be available at the place of use and can be found on the product page on www.baumer.com



Approved as an electronic device for railway applications.

For more information about approvals and certification, please see the product page on www.baumer.com.

7. Electrical connection

- ✓ A voltage supply of 12 V to 30 V DC is provided.
- ▶ Switch off supply voltage.
- ▶ Connect sensor in accordance with the pin assignment.

Terminal assignment

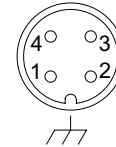

Housing dimensions available only for a plug connector in stainless steel

Output type	Equivalent circuit	Function	M12-A 4-pin	Cable outlet
PNP		+ Vs	1	brown
		SW1 (NO)	4	black
		SW1 (NC)	2	white
		GND (0 V)	3	blue
NPN		+ Vs	1	brown
		SW1 (NO)	4	black
		SW1 (NC)	2	white
		GND (0 V)	3	blue

8. Electrical connection in explosion hazard areas

Depending on the variant, the LBFS is approved for most explosion hazard areas.



DANGER

Risk of fatal accident due to a wrongly connected sensor

- ▶ In explosive gas atmospheres of zone 0 or 1, use Baumer isolation barriers or Zener barriers.
- ▶ In explosive dust atmospheres, use insulated cable to IP67.
- ▶ Allow only persons trained in explosion protection to perform the installation.

8.1 Explosive gas atmospheres zone 0 and 1

The LBFS can be used in explosion hazard areas of zone 0 or zone 1. Sensors with PNP can use Baumer isolation barriers which are easy to install. Sensors with NPN must use Zener barriers.

Approval for LBFS-1xxxx.x: ATEX II 1G Ex ia IIC T4/T5

Approval for LBFS-4xxxx.x: ATEX II 1G Ex ia IIC T4/T5 and ATEX II 1D Ex ta IIIC T100 °C Da

LBFS-1xxx1.x (PNP):

- ▶ Use PROFSI3-B25100-ALG-LS isolation barriers for the connection.

LBFS-1xxx2.x (NPN):

- ▶ Use Zener barriers for the connection.

LBFS-4xxxx.x and additional dust atmospheres:

- ▶ Use insulated cable to IP67.
- ▶ Secure cables with external strain relief at a distance 5 centimeters from the sensor.

All LBFS in zone 0 and zone 1

- ▶ Comply with the following temperatures, connection values and circuit diagram.

ATEX II 1 G Ex ia IIC T4/T5

Highest values for selection of barriers	Ui: 30 V DC Ii: 100 mA Pi: 0,75 W
Internal capacitance:	Ci: 43 nF ¹⁾
Internal inductance:	Li: 10 µH ²⁾
Temperature class	
■ Standard version	T4: -40 < Tamb < 85 °C T5: -40 < Tamb < 74 °C,
■ Cable version	T5: -25 < Tamb < 70 °C

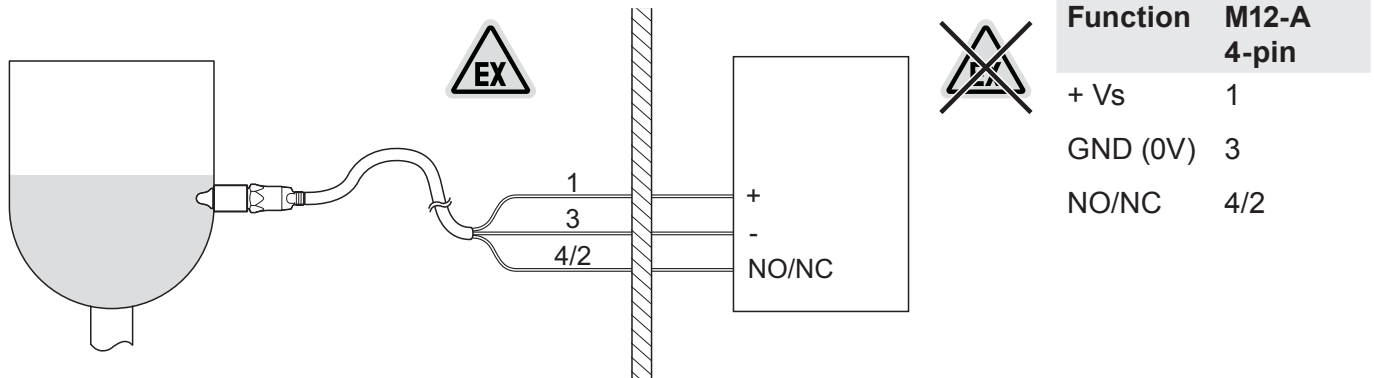

PNP output: PROFSI3-B25100-ALG-LS

NPN output: Zener barrier

- 1) For cable version LBFS-x2xxx.x add 0.17 nF/meter to Ci for cable lengths above 5 meter.
For hanging version LBFS-xx52x.x add 0.20 nF/meter to Ci for cable lengths above 1.5 meter.
- 2) For cable version LBFS-x2xxx.x add 0.27 µH/meter to Li for cable lengths above 5 meter.
For hanging version LBFS-xx52x.x add 1.13 µH/meter to Li for cable lengths above 1.5 meter.

8.2 Explosive dust atmospheres zones 20, 21 and 22

The LBFS can be used in explosion hazard areas of zone 20, 21 and 22.

Approval for LBFS-2xxxx.x: ATEX II 1D Ex ta IIIC T100 °C Da

LBFS-2xxxx.x:

- ▶ Use insulated cable to IP67.
- ▶ Secure cables with external strain relief at a distance 5 centimeters from the sensor.
- ▶ Comply with the following temperatures, connection values and circuit diagram.

ATEX II 1 D Ex ta IIIC T100 °C Da

Supply range	Un: 30 V DC max. In: 100 mA max.
Temperature class	T100 °C:
■ Standard version	-40 < Tamb < 85 °C
■ Cable version	-25 < Tamb < 70 °C
Surface temperature	100 °C max.
Protection class for cable accessories	IP67

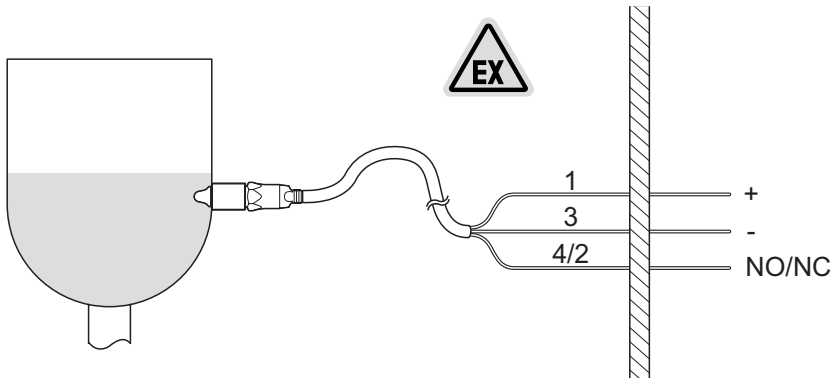

Function	M12-A 4 pin
+ Vs	1
GND (0V)	3
NO/NC	4/2

8.3 Explosive gas atmospheres zone 2

The LBFS can be used in explosion hazard areas of zone 2.
Approval for LBFS-3xxxx.x: ATEX II 3G Ex nA IIC T4/T5

LBFS-3xxxx.x:

- ▶ Comply with the following temperatures, connection values and circuit diagram

ATEX II 3 G Ex nA IIC T4/T5

Supply range	Un: 30 V DC max. In: 100 mA max.
Temperature class	
■ Standard version	T4: $-40 < T_{amb} < 85 \text{ °C}$ T5: $-40 < T_{amb} < 74 \text{ °C}$
■ Cable version	T5: $-25 < T_{amb} < 70 \text{ °C}$

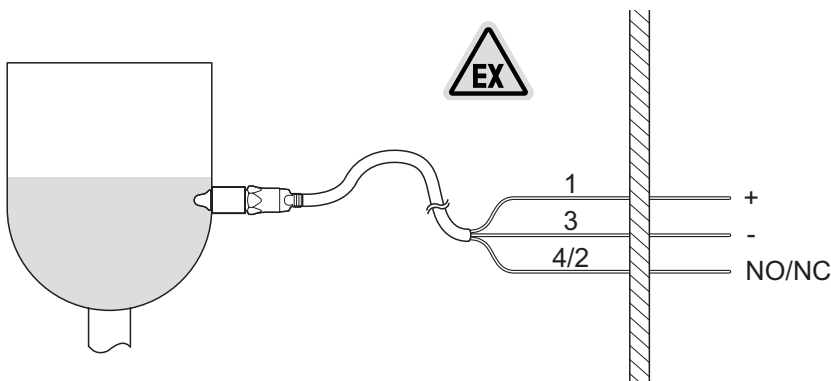

Function	M12-A 4 pin
+ Vs	1
GND (0V)	3
NO/NC	4/2

9. Configuration

The sensor can be configured with the FlexProgrammer. This allows switching points and damping values to be selected as required. In addition pulse width modulation can be specified for the signal.

Examples for pulse width modulation

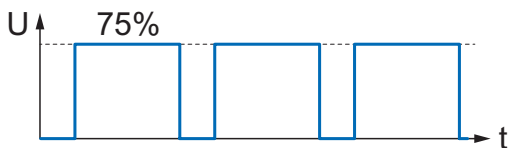
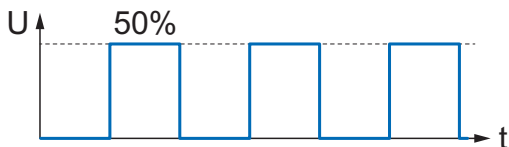
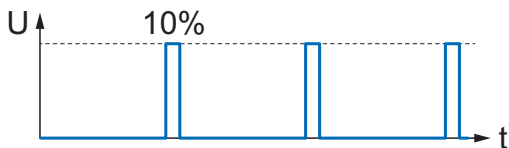

Configuring with FlexProgrammer and PC

- ▶ Connect FlexProgrammer to sensor.
- ▶ Connect FlexProgrammer to PC and set parameters (see FlexProgrammer instructions).

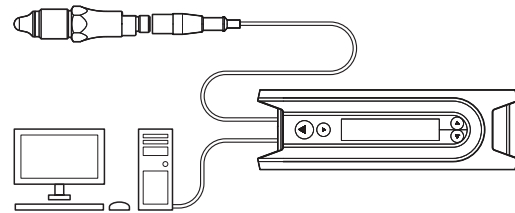

Copying configuration with FlexProgrammer

- ▶ Copy the configuration of one sensor to another sensor using FlexProgrammer (see FlexProgrammer instructions)

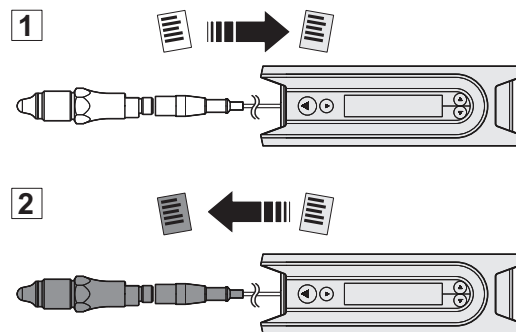

10. Operation

Standard operation with factory settings

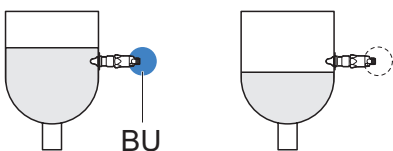

- BU = blue: Switched output, active
- LED does not light up: Switched output, inactive

LED indication for "Power-On"

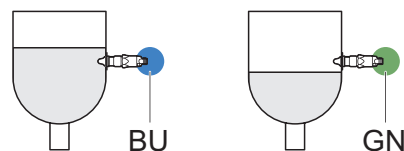

- BU = blue: Switched output, active
- GN = green: Switched output, inactive

A green LED can be activated indicating „Power-On“ by using the FlexProgrammer.

Application-specific settings: see chapter “15. Factory settings and user settings” on page 16.

11. Cleaning, maintenance and repair

Cleaning

- ▶ Clean, disinfect or sterilize sensor as needed (CIP/SIP).

Maintenance

Regular maintenance is not required.

Repair

- Do not repair the sensor yourself.
- ▶ Send damaged sensor to Baumer.

12. Disposal



- ▶ Do not dispose of in household waste.
- ▶ Separate materials and dispose of in compliance with nationally applicable regulations.

13. Accessories

For adapter and other accessories see www.baumer.com.

14. Technical data

Environmental conditions

Operating temperature range	■ -40...+85 °C
Storage temperature range	■ -40...+85 °C
Ambient humidity	■ < 98 % RH, condensing
Protection class	■ IP67 ■ IP69K (with appropriate cable)
Oscillations (sinusoidal) (EN 60068-2-6)	■ 1.6 mm p-p (2...25 Hz), 4 g (25...100 Hz), 1 octave / min.

Power supply

Voltage supply range	■ 12...30 V DC
Reverse polarity protection	■ yes
Current consumption (without load)	■ 25 mA typ., 50 mA max.
Power-up time	■ < 2 s

Features

Repeatability	■ ± 1 mm
Hysteresis	■ ± 1 mm
Response time	■ 0.1 s
Damping	■ 0.0...10.0 s (configurable)

Output signal

Output type	■ PNP ■ NPN
Current load	■ 20 mA max.
Short circuit protection	■ yes
Voltage drop	■ PNP: (+Vs -1.5 V) ± 0.5 V, Rload = 10 kΩ ■ NPN: (+1.5 V) ± 0.5 V, Rload = 10 kΩ
Leakage current	■ ± 100 µA max.
Switching logic	■ Normally open (NO), active low ■ Normally closed (NC), high enabled

Cable version

Operating temperature range	■ -25...+70 °C (if cable is not moved) ■ -5...+70 °C (if cable is moved)
Bending radius min.	■ r ≥ 10 mm

Process conditions for ambient temperatures < 50 °C						
Type	Process connection	BCID	Process temperature continuous	Process pressure	Process temperature t < 1 h	Process pressure t < 1 h
			[°C]	[bar]	[°C]	[bar]
			Tamb < 50 °C		Tamb < 50 °C	
LBFS-xx1xx.x	G 1/2 A ISO 228-1 BSC	G07	-40...115	-1...100	135	-1...100
LBFS-xxGxx.x	G 1/2 A ISO 228-1 BSC with cooling neck ¹⁾	G07	-40...150	-1...100	N/A	N/A
LBFS-xxAxx.x	G 1/2 A DIN 3852-E, NBR seal	G51	-40...115	-1...100	135	-1...100
LBFS-xxBxx.x	G 1/2 A DIN 3852-E, FKM (Viton®) seal	G51	-40...115	-1...100	135	-1...100
LBFS-xx4xx.x	G1/2 A hygienic	A03	-40...115	-1...10	135	-1...5
LBFS-xxKxx.x	G1/2 A hygienic, length 82 mm	A03	-40...115	-1...100	135	-1...100
LBFS-xxLx.x	G1/2 A hygienic, adjustable connection	A03	-40...200	-1...5	N/A	N/A
LBFS-xx5xx.x	G 1/2 A ISO 228-1 for internal installation	T10	-40...85	-1...100	N/A	N/A
LBFS-xx2xx.x	G 3/4 A ISO 228-1	G10	-40...115	-1...100	135	-1...100
LBFS-xx3xx.x	G 1 A ISO 228-1	G11	-40...115	-1...100	135	-1...100
LBFS-xxNxx.x	1/2-14 NPT	N02	-40...115	-1...100	135	-1...100
LBFS-xxMxx.x	1/2-14 NPT with cooling neck	N02	-40...150	-1...100	N/A	N/A
LBFS-xx6xx.x	3/4-14 NPT	N03	-40...115	-1...100	135	-1...100
LBFS-xx7xx.x	M18x1 ISO 965	M11	-40...115	N/A	N/A	N/A
LBFS-xxExx.x	G 1/2 A DIN 3852-E, FKM (Viton®) seal, with cooling neck	G51	-40...150	-1...100	N/A	N/A

¹⁾ Not applicable for mounting with ZPW1-7x1

The temperature specifications apply to a maximum dip depth of the sensor tip into the process area of 20 mm.

Process conditions as a function of the ambient temperature

Type 1, 2, 3, 4, 6, 7, A, B, E, G, K, M, N

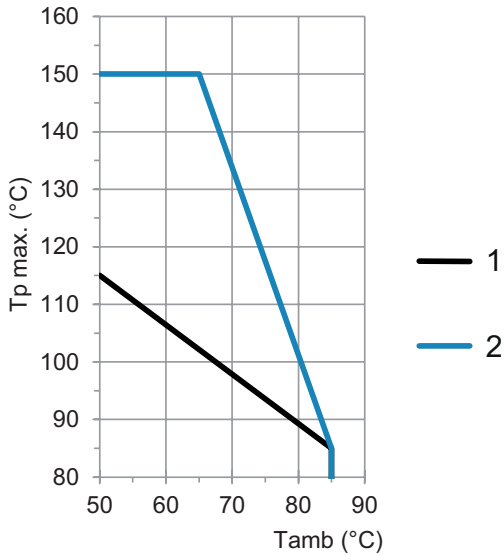

- 1 without cooling neck
- 2 with cooling neck (version E, G, M)

Tamb Ambient temperature
Tp Process temperature

Version L (adjustable connection)

Tp max. (°C)	Lp (mm)						
	25	35	50	65	90	145	
200							
190	20	35	45	65	90	140	
180	20	30	45	60	85	140	
170	20	25	40	55	85	135	
160		25	35	55	80	130	
150		20	25	50	75	130	
140		20	30	45	75	125	
130			25	45	70	120	
120			20	40	65	115	
110			20	25	60	110	
100				30	55	105	
90				25	50	100	
80				20	45	95	
70					35	85	
60					35	65	
	35	40	45	50	55	60	65
	Tamb (°C)						

- 1 Range without restrictions

Tamb Ambient temperature
Tp Process temperature
Lp min. projecting length:

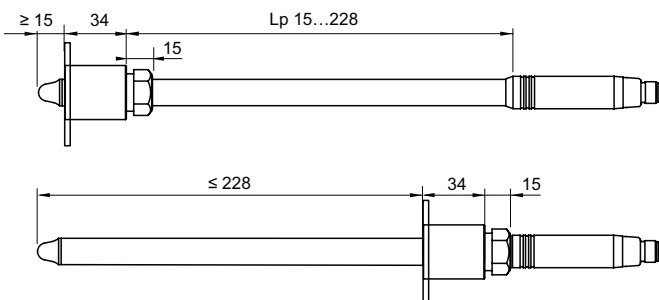

Lp min. projecting length:

15. Factory settings and user settings

Sensor parameter		Factory setting	User setting
SW1 (NO)	Switch window, min.	■ 0%	■
	Switch window, max.	■ 75.3%	■
	Switch window hysteresis	■ 2.4%	■
	Damping	■ 0.1 s	■